

E-commerce Note  
By DILLIP RANJAN NAYAK

**Basics of E-commerce:**

**Business:**-A business is an organization engaged in the trade of goods, services, or both to consumers.

**Commerce:** - The buying and selling of products and services between firms, usually in different status or countries.

**E-commerce:** - E-commerce means buying and selling of products or services over electronic systems such as the internet and other computer networks. Electronic commerce draws on technologies such as mobile commerce, electronic funds transfer, supply chain management, Internet marketing, online transaction processing, Electronic Data Interchange (EDI), inventory management systems, and automated data collection systems.

E-commerce businesses employ the following:

- Online shopping web sites for retail sales direct to consumers
- Providing or participating in online marketplaces, which process third-party business-to-consumer or consumer-to-consumer sales
- Business-to-business buying and selling
- Gathering and using demographic data through web contacts and social media
- Business-to-Business (B2B) electronic data interchange
- Marketing to prospective and established customers by e-mail or fax (for example, with newsletters)
- Online financial exchanges for currency exchanges or trading purposes

**Basic Elements of e-commerce:**

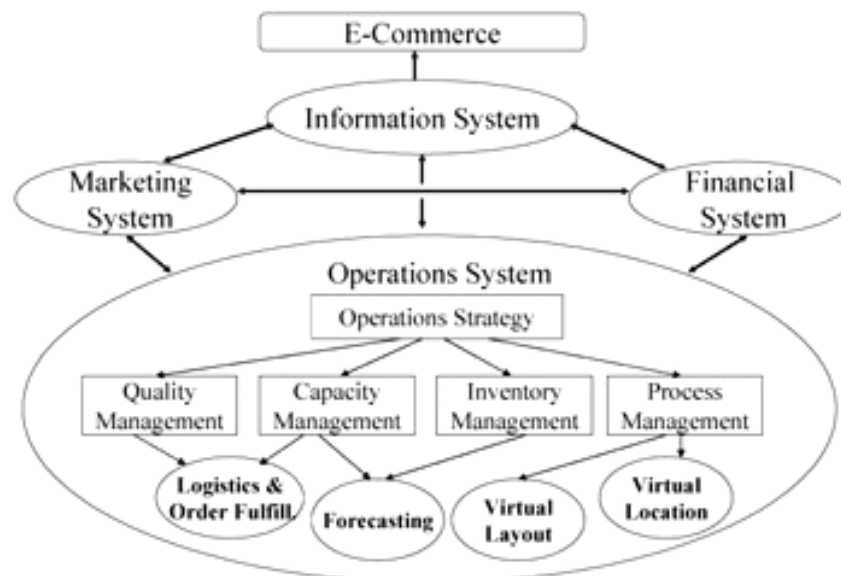

## E-commerce framework

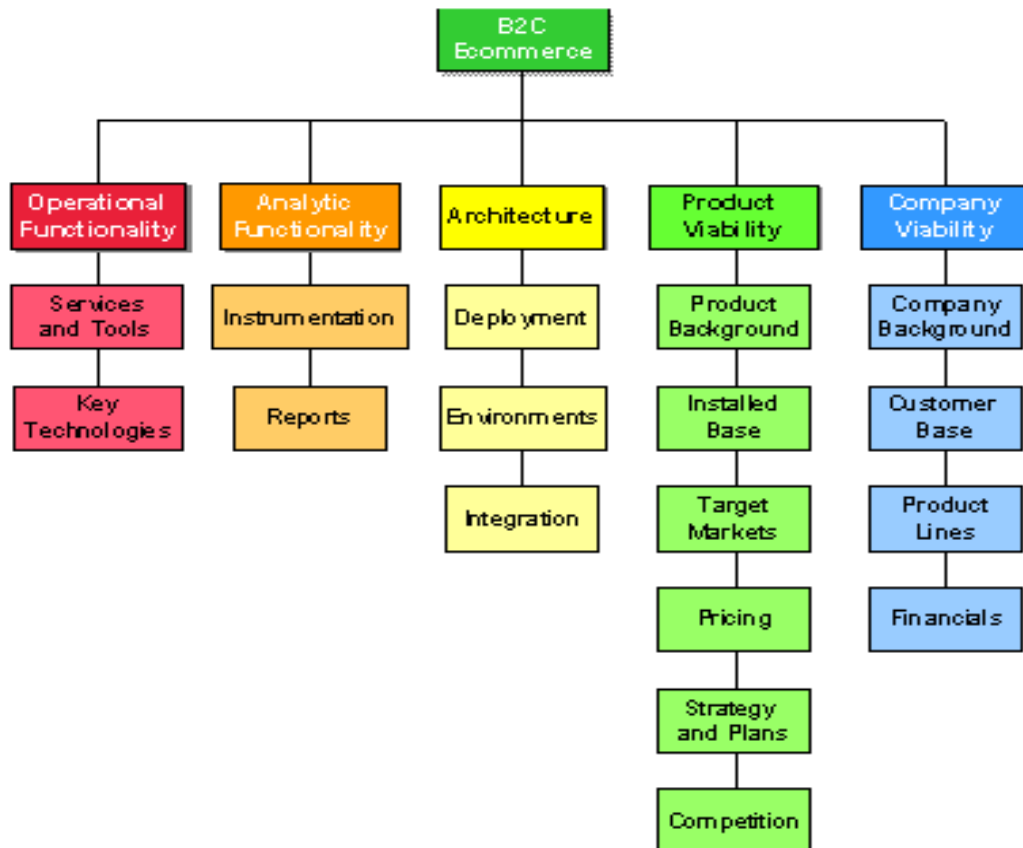

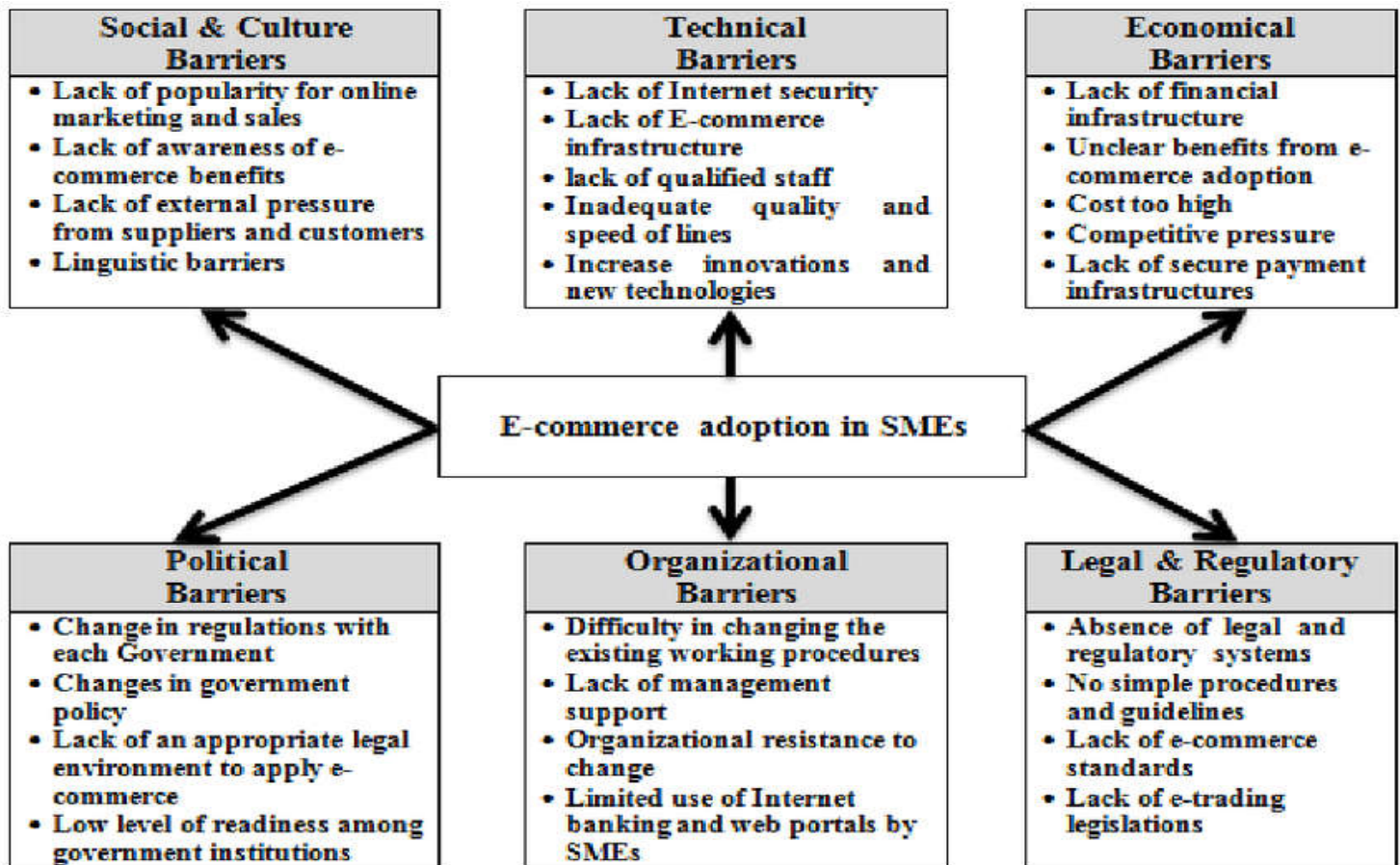

## Conceptual framework

Here are seven important infrastructure decisions that E-commerce businesses face.

1. Marketing
2. Facilities
3. Customer Service
4. Information Technology
5. Fulfillment
6. Finance and Administration
7. Human Resource

## Difference between E-business and E-commerce:-

In both the cases, E stands for “Electronic networks “ and describes the applications of Electronic network technology – including internet and electronic data interchange (EDI) – to improve and change business process . E-commerce covers outward - facing processes that touch customers, suppliers and external partners, including sales, marketing, order taking, delivery, customer service, purchasing of raw materials.

E-business includes E-commerce but also covers internal process such as production, inventory management, products development, finance, human resources, E-business strategy is more complex, productivity and cost savings.

Ex:-E-bay, Amazon.

### Activities of E-commerce

- a) Increasing the speed of service delivery.
- b) Use of computer networks to search and retrieve information for human
- c) Buying and selling of information, products and services via computer network.
- d) Faster customer response and improve services quality .
- e) Advertising on the internet.
- f) Online electronic commerce payments just like electronic funds transfer.

### Benefits of E-commerce

- a. The global nature of the technology.
- b. Low cost.
- c. Opportunity to reach hundreds of millions of people.
- d. Interactive nature.
- e. Variety of possibilities.
- f. Rapid growth of the supporting infrastructures.

### E-commerce benefits are classified into 3 types.

1. Benefits to organization.
2. Benefits to consumers.
3. Benefits to society.

## Technical Infrastructure

### Internet connectivity

The Internet's growth has become explosive and it seems impossible to escape the bombardment of *www.com*'s seen constantly on television, heard on radio, and seen in magazines. Because the Internet has become such a large part of our lives, a good understanding is needed to use this new tool most effectively. Internet is network of network means a global network of computers. Each computer connected to the Internet must have a unique address. Internet addresses are in the form of **nnn.nnn.nnn.nnn** (where nnn must be a number from 0 – 255). This address is known as an IP address. (IP stands for Internet Protocol; more on this later.)

The picture below illustrates two computers connected to the Internet; your computer with IP address 1.2.3.4 and another computer with IP address 5.6.7.8. The Internet is represented as an abstract object in-between. (As this paper progresses, the Internet portion of Diagram 1 will be explained and redrawn several times as the details of the Internet are exposed.)

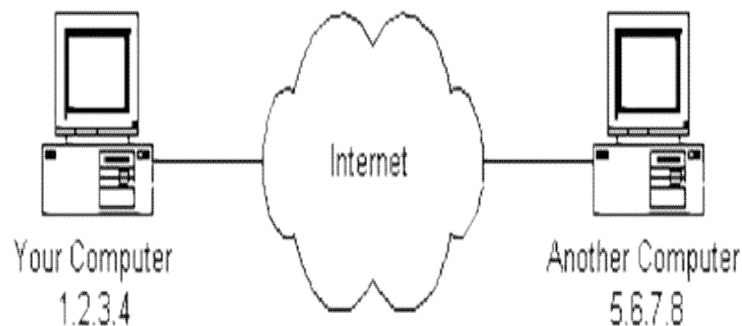
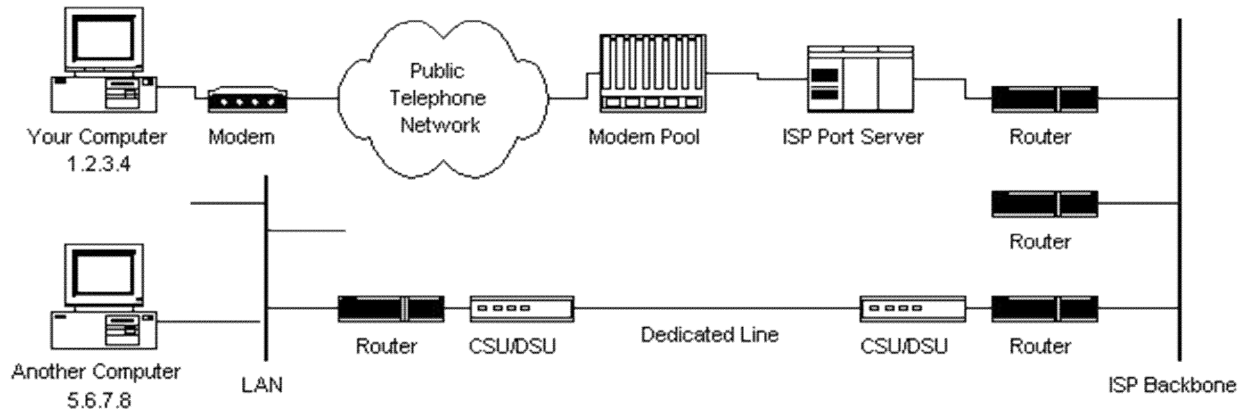

Diagram 1

If you connect to the Internet through an Internet Service Provider (ISP), you are usually assigned a temporary IP address for the duration of your dial-in session. If you connect to the Internet from a local area network (LAN) your computer might have a permanent IP address or it might obtain a temporary one from a DHCP (Dynamic Host

Configuration Protocol) server. In any case, if you are connected to the Internet, your computer has a unique IP address.

Diagram-2



### Protocol Stacks and Packets

Every computer needs one to communicate on the Internet and it is usually built into the computer's operating system (i.e. Windows, Unix, etc.). The protocol stack used on the Internet is referred to as the TCP/IP protocol stack because two major communication protocols are used. The TCP/IP stack looks like this:

Protocol Layer	Comments
Application Protocol Layer	Protocols specific to applications such as WWW, e-mail, FTP, etc.
Transfer Control Protocol Layer	TCP directs packets to a specific application on a computer using a port number.
Internet Protocol Layer	IP directs packets to a specific computer using IP address.
Hardware Layer/Physical Layer	Converts binary packet data to network signals and back. (E.g. Ethernet network card, modem for phone lines, etc.)

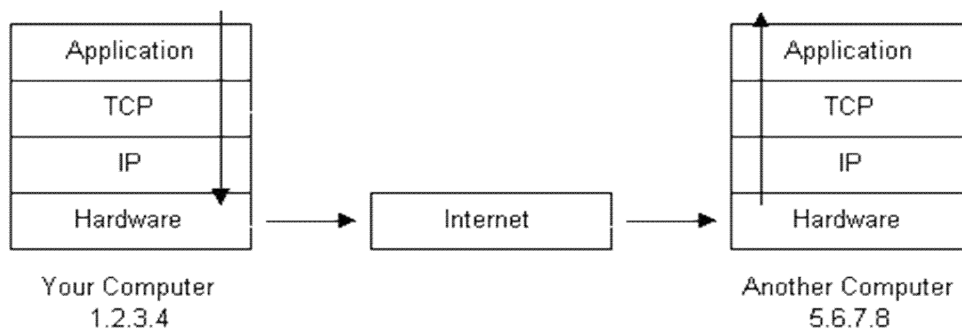

Diagram 3

### *Networking Infrastructure*

Here we see Diagram 1 is redrawn with more details. The physical connection through the phone network to the Internet Service Provider might have been easy to guess, but beyond that might bear some explanation.

The ISP maintains a pool of modems for their dial-in customers. This is managed by some form of computer (usually a dedicated one) which controls data flow from the modem pool to a backbone or dedicated line router. This setup may be referred to as a port server, as it 'serves' access to the network. Billing and usage information is usually collected here as well.

After your packets traverse the phone network and your ISP's local equipment, they are routed onto the ISP's backbone or a backbone the ISP buys bandwidth from. From here the packets will usually journey through several routers and over several backbones, dedicated lines, and other networks until they find their destination, the computer with address 5.6.7.8.

### Internet Infrastructure

The Internet backbone is made up of many large networks which interconnect with each other. These large networks are known as **Network Service Providers** or **NSPs**. Some of the large NSPs are UUNet, IBM, BBN Planet, SprintNet, PSINet, as well as others. These networks **peer** with each other to exchange packet traffic. Each NSP is required to connect to three **Network Access Points** or **NAPs**. At the NAPs, packet traffic may jump from one NSP's backbone to another NSP's backbone. NSPs also interconnect at **Metropolitan Area Exchanges** or **MAEs**. MAEs serve the same purpose as the NAPs but are privately owned. NAPs were the original Internet interconnect points. Both NAPs and MAEs are referred to as Internet Exchange Points or **IXs**. NSPs also sell bandwidth to smaller networks, such as ISPs and smaller bandwidth providers. Below is a picture showing this hierarchical infrastructure.

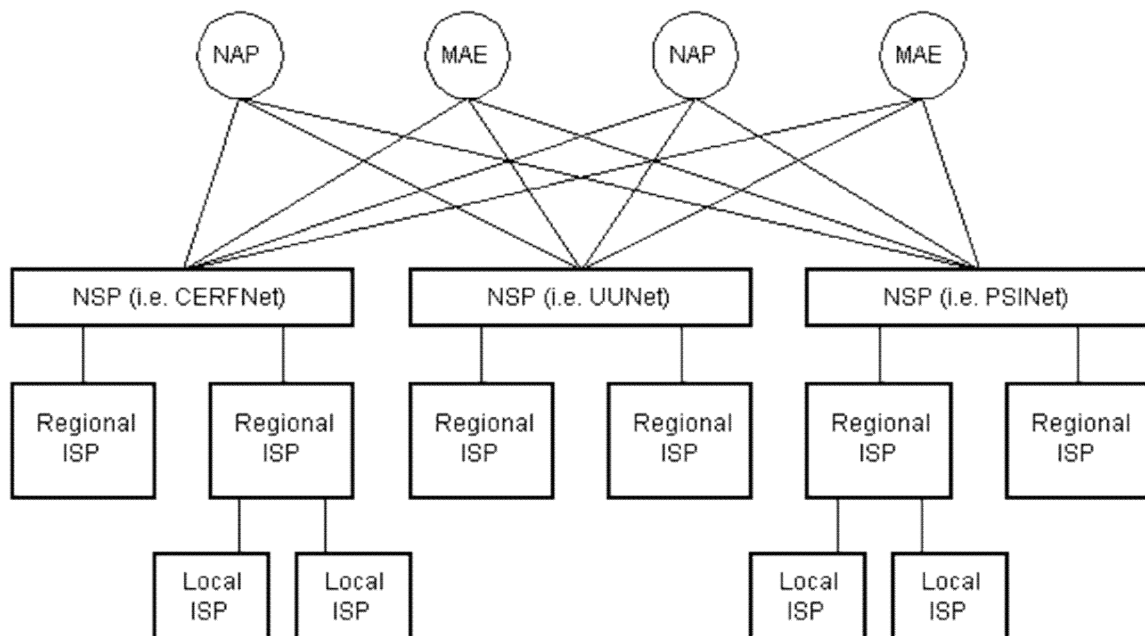

Diagram 4

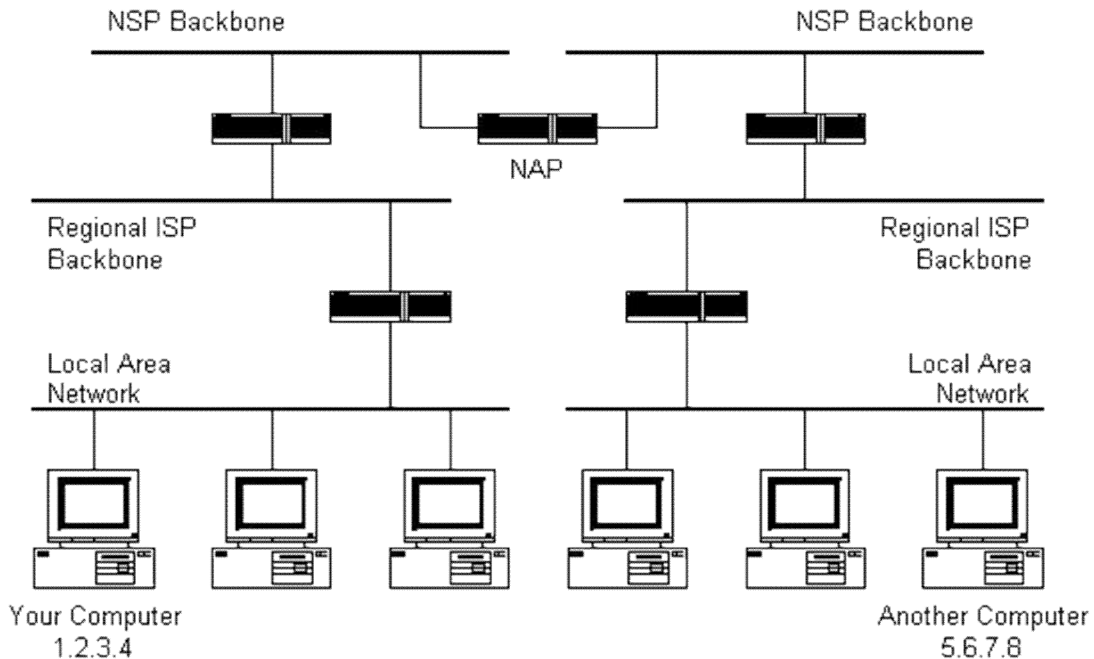

Diagram 5

### Application Protocols: HTTP and the World Wide Web

One of the most commonly used services on the Internet is the World Wide Web (WWW). The application protocol that makes the web work is **Hypertext Transfer Protocol** or **HTTP**. HTTP is the protocol that web browsers and web servers use to communicate with each other over the Internet. It is an application level protocol because it lies on top of the TCP layer in the protocol stack and is used by specific applications to talk to one another. In this case the applications are web browsers and web servers.

HTTP is a connectionless text based protocol. Clients (web browsers) send requests to web servers for web elements such as web pages and images. After the request is serviced by a server, the connection between client and server across the Internet is disconnected. A new connection must be made for each request. Most protocols are connection oriented. This means that the two computers communicating with each other keep the connection open over the Internet. HTTP does not however apply this. Before an HTTP request can be made by a client, a new connection must be made to the server.

When you type a URL into a web browser, this is what happens:

1. If the URL contains a domain name, the browser first connects to a domain name server and retrieves the corresponding IP address for the web server.
2. The web browser connects to the web server and sends an HTTP request (via the protocol stack) for the desired web page.
3. The web server receives the request and checks for the desired page. If the page exists, the web server sends it. If the server cannot find the requested page, it will send an HTTP 404 error message. (404 means 'Page Not Found' as anyone who has surfed the web probably knows.)
4. The web browser receives the page back and the connection is closed.
5. The browser then parses through the page and looks for other page elements it needs to complete the web page. These usually include images, applets, etc.
6. For each element needed, the browser makes additional connections and HTTP requests to the server for each element.

7. When the browser has finished loading all images, applets, etc. the page will be completely loaded in the browser window.

#### Application Protocols: SMTP and Electronic Mail

Another commonly used Internet service is electronic mail. E-mail uses an application level protocol called **Simple Mail Transfer Protocol** or **SMTP**. SMTP is also a text based protocol, but unlike HTTP, SMTP is connection oriented. SMTP is also more complicated than HTTP. There are many more commands and considerations in SMTP than there are in HTTP.

#### Transfer Control Protocol

Under the application layer in the protocol stack is the TCP layer. When applications open a connection to another computer on the Internet, the messages they send (using a specific application layer protocol) get passed down the stack to the TCP layer. **TCP is responsible for routing application protocols to the correct application on the destination computer.** To accomplish this, port numbers are used. Ports can be thought of as separate channels on each computer. For example, you can surf the web while reading e-mail. This is because these two applications (the web browser and the mail client) used different port numbers. When a packet arrives at a computer and makes its way up the protocol stack, the TCP layer decides which application receives the packet based on a port number.

TCP works like this:

- When the TCP layer receives the application layer protocol data from above, it segments it into manageable 'chunks' and then adds a TCP header with specific TCP information to each 'chunk'. The information contained in the TCP header includes the port number of the application the data needs to be sent to.
- When the TCP layer receives a packet from the IP layer below it, the TCP layer strips the TCP header data from the packet, does some data reconstruction if necessary, and then sends the data to the correct application using the port number taken from the TCP header.

This is how TCP routes the data moving through the protocol stack to the correct application.

TCP is not a textual protocol. **TCP is a connection-oriented, reliable, byte stream service.** Connection-oriented means that two applications using TCP must first establish a connection before exchanging data. TCP is reliable because for each packet received, an acknowledgement is sent to the sender to confirm the delivery. TCP also includes a checksum in it's header for error-checking the received data. The TCP header looks like this:

#### Internet Protocol

Unlike TCP, **IP is an unreliable, connectionless protocol.** IP doesn't care whether a packet gets to it's destination or not. Nor does IP know about connections and port numbers. **IP's job is to send and route packets to other computers.** IP packets are independent entities and may arrive out of order or not at all. It is TCP's job to make sure packets arrive and are in the correct order. About the only thing IP has in common with TCP is the way it receives data and adds it's own IP header information to the TCP data.

#### E-commerce software

E-commerce software is the engine behind the scenes of an online store, making it possible to easily manage inventory, add or remove products, calculate taxes, and everything else required to manage a website and fulfill orders.

E-commerce software simplifies intricate processes in a friendly user interface that enables people of non-technical backgrounds to oversee an entire ecommerce operation. Despite the ease of use that e-commerce



software brings to an online business, it is a multifaceted and complex machine. The purpose of e-commerce software is to put everything you need to run your store in one place

### **E-COMMERCE SECURITY**

E-commerce security is the protection of e-commerce assets from unauthorized access, use, alteration, or destruction.

Six dimensions of e-commerce security

1. Integrity: prevention against unauthorized data modification
2. No repudiation: prevention against any one party from renegeing on an agreement after the fact
3. Authenticity: authentication of data source
4. Confidentiality: protection against unauthorized data disclosure
5. Privacy: provision of data control and disclosure
6. Availability: prevention against data delays or removal

### **THREATS**

1. Intellectual property threats -- use existing materials found on the Internet without the owner's permission, e.g., music downloading, domain name (cyber squatting), software pirating
2. Client computer threats
  - Trojan horse
  - Active contents
  - Viruses
3. Communication channel threats
  - Sniffer program
  - Backdoor
  - Spoofing
  - Denial-of-service
4. Server threats
  - Privilege setting
  - Server Side Include (SSI), Common Gateway Interface (CGI)
  - File transfer
  - Spamming

A procedure that recognizes, reduces, or eliminates a threat

1. Intellectual property protection
  - Legislature
  - Authentication
2. Client computer protection
  - Privacy -- Cookie blockers;
  - Digital certificate (Figure 5.9)
  - Browser protection
  - Antivirus software
  - Computer forensics expert
3. Communication channel protection
  - Encryption
    - Public-key encryption (asymmetric) vs Private-key encryption (symmetric) (Figure 5-6)
    - Encryption standard: Data Encryption Standard (DES), Advanced Encryption Standard (AES)
  - Digital signature
    - Bind the message originator with the exact contents of the message
    - A hash function is used to transform messages into a 128-bit digest (message digest).
    - The sender's private key is used to encrypt the message digest (digital signature)

- The message + signature are sent to the receiver
- The recipient uses the hash function to recalculate the message digest
- The sender's public key is used to decrypt the message digest
- Check to see if the recalculated message digest = decrypted message digest

#### 4. Server protection

Access control and authentication

Digital signature from user

Username and password

Access control list

## **The benefits of Ecommerce:**

### Benefits to organizations

1. E-commerce expands the market place to national and international level.
2. E-commerce decreases the cost of creating, processing, distributing, storing, and retrieving paper based information.
3. Ability for creation highly specialized business.
4. E-commerce reduces the time between the outlay of capital and the receipt of products and services.
5. E-commerce initiates business processes reengineering projects.

### Benefits to consumers:

The following are the benefits of E-commerce to consumer

1. E-commerce enables customer to shop transactions 24hrs a day, all year round from any location.
2. E-commerce provides customers with more choices they can select from many vendors and from many products.
3. Products E-commerce allows quick delivery.
4. Customer can retrieve relevant and detailed information in seconds, rather than days or weeks .
5. E-Commerce facilitates competition, which results in substantial discounts

### Benefits to society:

The following are the benefits of E-Commerce to society:

- 1.E-Commerce enables more individuals to work at home and to do less travelling for shopping resulting in less traffic on the roads and lower air pollution.
2. E-Commerce enables people in rural areas to enjoy products and services that are not available to them. This includes opportunities to learn professions and earn college degrees.
3. E-Commerce facilitates delivery of public services such as health care education and distribution of Government social services at a reduced cost and or improved quality.

## **Limitations of E-Commerce**

The limitations of E-Commerce can be categorized into

- 1) Technical
- 2) Non-Technical

Technical limitations of E-Commerce are:

1. There is a lack of system security, reliability, standards and some communication protocols.
2. There is insufficient telecommunication band width.
3. Soft ware development tools are changing rapidly.
4. It is difficult to integrate the internet and soft ware with some existing application data basis.

Non-Technical limitations are:

1. **COST AND JUSTIFICATION:** - The cost of developing E-Commerce in house is very costly and made mistakes due to lack of experience may result in delays.
2. **SECURITY AND PRIVACY:** - these issues are especially important in the B2C area, especially security issues which are privacy measures are constantly improved. EC Industry has a very long and difficult task of convincing customers that online transactions are secure and they will keep.
3. **LACK OF TRUST AND USER RESISTANCE:** - Customers do not trust on unknown faceless sellers, paperless transactions and electronic money.

**E-COMMERCE APPLICATIONS:**

1)E-MARKETING : E-Marketing also known as Internet marketing, Online marketing, Web marketing. It is the marketing of products or services over the internet. It is consider to be broad in scope because not refers to marketing on the internet but also done in Email and wireless media. E-Marketing ties together the creative and technical aspects of the internet, including design development, advertising and sales. Internet marketing is associated with several business models ie., B2C, B2B, C2C. Internet marketing is inexpensive when examine the ratio of cost to the reach of the target.

2)E-ADVERTISING: It is also known as online advertising it is a form of promotion that uses internet and world wide web to deliver marketing messages to attracts customers. Example: Banner ads, Social network advertising, online classified advertising etc. The growth of these particular media attracts the attention of advertisers as a more productive source to bring in consumers. An online advertisement also offers various forms of animation. The term online advertisement comprises all sorts of banner advertisement, email advertising, in game advertising and key soon.

3) E-BANKING OR INTERNET BANKING: Means any user with a personal computer and browser can get connected to his banks, website to perform any of the banking functions. In internet banking system the bank has a centralized data base i.e., web-enabled. example for E-Banking is ATM.

**SERVICES THROUGH E-BANKING:**

- Bill payment service.
- Fund Transfer
- Investing through internet Banking
- Shopping

4) MOBILE-COMMERCE: Mobile Commerce also known as M-Commerce, is the ability to conduct, commerce as a mobile device, such as mobile phone.

**SERVICES ARE:**

1. Mobile ticketing
2. Mobile Vouchers, Coupons and
3. Mobile contract purchase and delivery mainly consumes of the sale of ring tones, wallpapers and games of mobile phones.

5) E-LEARNING: E-Learning comprises all forms of electronically supported learning and teaching's-Learning specially the computer and network skills and knowledge's-Learning applications include web-based learning, computer-based learning. Content is delivered via. The internet, intranet, audio, or video tape, satellite TV, and ED-ROM.Computer-Based Learning, refers to the use of computers as a key component of the education environment.

6) ONLINE SHOPPING:- Online shopping is the process whereby consumer directly buy goods or services from a sell in real time, without an intermediary services over the internet . Online shoppers commonly use credit card to make payments, however some systems enable users to create accounts and pay by alternative means ,such as

1. Billing to mobile phones and landline.
2. Cheque.
3. Postal money order.

7) SEARCH ENGINE:- A web search engine is designed to search for information on the WWW and FTP servers. The search results are generally presented in list of result and are often called hits. The information may consist of web pages, images, information, and other types of files.

8) ONLINE TRADING:- An online trading community provides participants with a structured method for trading bantering (exchanging goods with goods) or selling goods and services. These communities often have forums and chat rooms, designed to facilitate communication between the members.

9) ENTERTAINMENT:-

The conventional media that have been used for entertainment are

1. Books/magazines.
2. Radio.
3. Television/films.
4. Video games.

## **ELECTRONIC PAYMENT SYSTEMS**

### **Electronic Payment Systems**

Definition: Electronic payment is a financial exchange that takes place online between buyers and sellers. The content of this exchange is usually as encrypted credit card numbers, electronic cheques or cash. The various factors that have the financial intuitions to make use of electronic payments are:

1. Decreased technology cost. Interest is becoming free almost everywhere in the world.
2. Reduced operational and proceeding cost.
3. Increasing online commerce.

**Advantages:-**

1. Privacy.
2. Integrity.
3. Compatibility.
4. Good transaction efficiency.
5. Acceptability.
6. Convenience.
7. Mobility.
8. Low financial risk.

## 9. Anonymity.

- 1) The greatest advantage of e-payments is the convenience. i.e. customer can pay from any locations 24 hours day, 7 days a week.
- 2) E-payments have reduced the amount of time spent on bill management or payment by about 60%.
- 3) Compared to the cost of postage, online payment can save the money.
- 4) E-payments are secure.

### **Risks in Electronic payment systems:-**

There are three major risks in the operation of the payment system

- 1) Fraud or mistake.
- 2) Privacy issues.
- 3) Credit Risk.

#### 1) Fraud or Mistake:

All electronic payment systems need some ability to keep automatic records. Once information has been captured electronically, it is easy and inexpensive to maintain. The need for record keeping for purpose of risk management like fraud or any sort of mistakes.

#### 2) Privacy Issues:

The electronic payment system must ensure and maintain privacy. The privacy of customers should be protected as much as possible. privacy must be maintained against unauthorized access. For any type of transaction trusted third-parties will be needed for all tenacity and good faith.

#### 3) Managing Credit Risk:

Credit or systematic risk is a major concern in net settlement systems because a bank's failure to settle its net position could lead to a chain reaction of bank failures.

## **TYPES OF ELECTRONIC PAYMENTS SYSTEM**

Electronic payment systems are mainly used in banking, retail, health –care, online markets, etc., Electronic payment system also called as Electronic Funds Transfer (EFT) It is defined as “ any transfer of funds initiate through an electronic terminal telephonic instrument or computer or authorize a financial institution to debit or credit an account”

EFT (Electronic Funds Transfer) can be categorized in to three types.

### 1) **Banking and financial payments**

Large-scale or wholesale payments (e.g., Bank-to-bank transfer)

Small-scale or retail payments (e.g., automated teller machines)

Personal banking (e.g., bill payment)

### 2) **Retailing payments**

Credit Cards (e.g., VISA or MasterCard)

Private label credit/debit cards (e.g., J.C. Penney Card)

Charge Cards (e.g., American Express)

### 3) **Online electronic payments.**

i) **Token-based payment systems** Electronic cash (e.g., DigiCash) Electronic cheques (e.g., NetCheque) Smart cards or debit cards (e.g., Mondex Electronic Currency Card)

ii) **Credit card-based payments systems** Encrypted Credit Cards (e.g., World Wide Web form-based encryption) Third-party authorization numbers (e.g., First Virtual)

### **Electronic Cash ( E-cash)**

E-cash is a new concept in online payment system because it combines computerized convenience with security and privacy. E-cash presents some interesting characteristics that should make it an attractive alternative for payment over the internet.

### **Properties of E-cash:**

There are four properties of E-cash

- : - Monetary Value
- : - Interpretability
- : - Irretrievability and security

E-cash must have a monetary value; it must be backed by cash, bank-authorized credit or a bank certified cashier cheque. When e-cash created by one bank is accepted by others.

E-cash must be Interpretable i.e. this can be cleared in multiple banks, because multiple banks are required with an international clearing house that handles the exchangeability issues because all customers are not going to be using the same bank or even be in the same country.

E-cash must be storable and retrievable from any place telephone or personal communication device and withdraw from and deposit into banking A/C. E-cash should not be easy to copy, this includes preventing or detecting duplication.

### **Working of E-cash:**

E-cash is based on cryptographic systems called “Digital Signatures”. This method involves a pair of numeric keys (Very large no’s)

- One for locking (encoding)
- Another for unlocking (decoding)
- Encoding key is kept private and the decoding key is made public.

These digital signatures are very secured way for e-cash.

Electronic cash fulfills two main functions:

- 1) As a medium of exchange.
- 2) As a store of value.

Digital money is a perfect medium of exchange e-cash would be allowed to realize its potential for bypassing the transaction costs of the foreign exchange market.

## **Electronic Cash Storage:**

- Two methods

– On-line

- Individual does not have possession personally of electronic cash
- Trusted third party, e.g. e-banking, bank holds customers' cash accounts

– Off-line

- Customer holds cash on smart card or electronic wallet
- Fraud and double spending require tamper-proof encryption

The purchase of e-cash from an on-line currency server (or bank) involves two steps:

- Establishment of an account
- Maintaining enough money in the account to bank the purchase.

- Once the tokens are purchased, the e-cash software on the customer's PC stores digital money undersigned by a bank.
- The users can spend the digital money at any shop accepting e-cash, without having to open an account there or having to transmit credit card numbers.
- As soon as the customer wants to make a payment, the software collects the necessary amount from the stored tokens.

## **Smart Cards & Electronic Payment Systems:**

- Smart cards have been in existence since the early 1980s and hold promise for secure transactions using existing infrastructure.
- Smart cards are credit and debit cards and other card products enhanced with microprocessors capable of holding more information than the traditional magnetic stripe.
- The smart card technology is widely used in countries such as France, Germany, Japan, and Singapore to pay for public phone calls, transportation, and shopper loyalty programs.

### **Types of Smart Cards:**

- Relationship-Based Smart Credit Cards
- Electronic Purses also known as debit cards
  - **Relationship-Based Smart Credit Cards:**
  - It is an enhancement of existing cards services &/ or the addition of new services that a financial institution delivers to its customers via a chip-based card or other device.
  - These services include access to multiple financial accounts, value-added marketing programs, or other information card holders may want to store on their card.
  - It includes access to multiple accounts, such as debit, credit, cash access, bill payment & multiple access options at multiple locations.

### ➤ **Electronic Purses:**

To replace cash and place a financial instrument are racing to introduce electronic purses wallet-sized smart cards embedded with programmable microchips that store sums of money for people to use instead of cash for everything.

The electronic purse works in the following manner:

- After purse is loaded with money at an ATM, it can be used to pay for candy in a vending machine with a card reader.
- It verifies card is authentic & it has enough money, the value is deducted from balance on the card & added to an e-cash & remaining balance is displayed by the vending machine.

## **Credit Card-Based Electronic Payment Systems:**

Payment cards are all types of plastic cards that consumers use to make purchases:

– Credit cards

- Such as a Visa or a MasterCard, has a preset spending limit based on the user's credit limit.

– Debit cards

- Removes the amount of the charge from the cardholder's account and transfers it to the seller's bank.

--Charge cards

- Such as one from American Express, carries no preset spending limit.

Advantages:

- Payment cards provide fraud protection.
- They have worldwide acceptance.
- They are good for online transactions.

Disadvantages:

Payment card service companies charge merchants per-transaction fees and monthly processing fees.

## **Electronic payments Issues:**

- Secure transfer across internet
- High reliability: no single failure point
- Atomic transactions
- Anonymity of buyer
- Economic and computational efficiency: allow micropayments
- Flexibility: across different methods
- Scalability in number of servers and users

## **Security Requirements In Electronic Payment Systems:**

➤ Integrity and authorization

A payment system with integrity allows no money to be taken from a user without explicit authorization by that user. It may also disallow the receipt of payment without explicit consent, to prevent occurrences of things like unsolicited bribery. Authorization constitutes the most important relationship in a payment system. Payment can be authorized in three ways: via out-band authorization, passwords, and signature.

➤ Out-band authorization

In this approach, the verifying party (typically a bank) notifies the authorizing party (the payer) of a transaction. The authorizing party is required to approve or deny the payment using a secure, out-band channel (such as via surface mail or the phone). This is the current approach for credit cards involving mail orders and



telephone orders: Anyone who knows a user's credit card data can initiate transactions, and the legitimate user must check the statement and actively complain about unauthorized transactions. If the user does not complain within a certain time (usually 90 days), the transaction is considered —approved by default.

➤ Password authorization

A transaction protected by a password requires that every message from the authorizing party include a cryptographic check value. The check value is computed using a secret known only to the authorizing and verifying parties. This secret can be a personal identification number, a password, or any form of shared secret. In addition, shared secrets that are short - like a six-digit PIN - are inherently susceptible to various kinds of attacks. They cannot by themselves provide a high degree of security. They should only be used to control access to a physical token like a smart card (or a wallet) that performs the actual authorization using secure cryptographic mechanisms, such as digital signatures.

➤ Signature authorization

In this type of transaction, the verifying party requires a digital signature of the authorizing party. Digital signatures provide non repudiation of origin.

➤ Confidentiality

Some parties involved may wish confidentiality of transactions. Confidentiality in this context means the restriction of the knowledge about various pieces of information related to a transaction: the identity of payer/payee, purchase content, amount, and so on. Typically, the confidentiality requirement dictates that this information be restricted only to the participants involved. Where anonymity or un-traceability are desired, the requirement may be to limit this knowledge to certain subsets of the participants only, as described later.

➤ Availability and reliability

All parties require the ability to make or receive payments whenever necessary. Payment transactions must be atomic: They occur entirely or not at all, but they never hang in an unknown or inconsistent state. No payer would accept a loss of money (not a significant amount, in any case) due to a network or system crash. Availability and reliability presume that the underlying networking services and all software and hardware components are sufficiently dependable. Recovery from crash failures requires some sort of stable storage at all parties and specific resynchronization protocols. These fault tolerance issues are not discussed here, because most payment systems do not address them explicitly.

## **Operational Risks:**

### **Risks Involve in E-Cash are:**

- 1) The time over which given electronic money is valid
- 2) How much can be stored on and transferred by electronic money.
- 3) No. of transactions made during given period of time.

To make purchasing using E-cash:

- 1) Establishment of an account
- 2) Maintaining enough money in the a/c to make the purchase.

## **Legal Issues:**

Electronic cash will force bankers and regulators to make tough choices that will shape the form of lawful commercial activity related to electronic commerce.

1. The consumers acquire an OTP account numbers by filling our registration form. This will give the OTP a customer information profile.

2. To purchase in on-line the consumer requests the form the merchant by quoting OTPPP account number.
3. The merchant contacts with OTPPP payment server with the customer's account number
4. The OTPPP payment server verifies the customer's account number for the vendor and check for stuffiest funds.
5. The OTPPP payment server sends an electronic message to the buyer. The buyer responds to this message in one of two ways. Yes I agree to pay; No; I will not pay;
6. If the OTPPP payment servers get a yes from the customer, the merchant is informed and the customer is allowed to download the material immediately.
7. The OTPPP will not debit the buyer's account until it receives conformation of purchase completion.

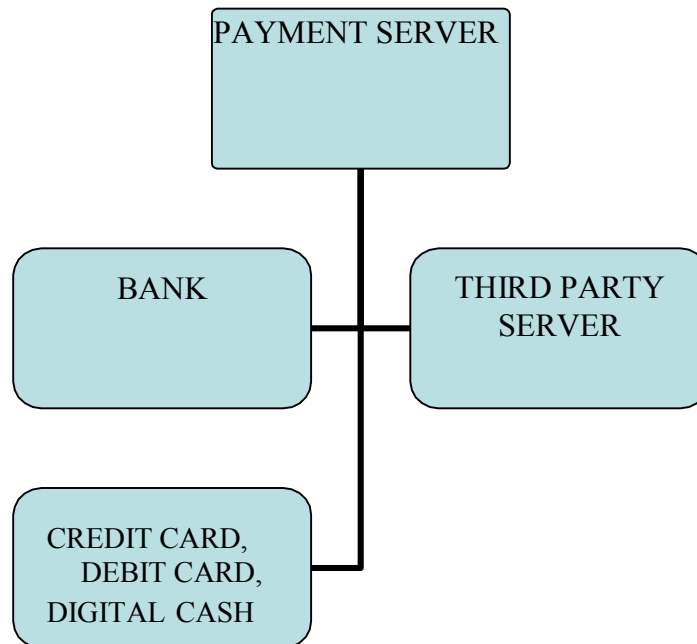

A medium of payment between remote buyers and sellers in cyberspace: electronic cash, software wallets, smart cards, credit/debit cards

## **EDI-ELECTRONIC DATA INTERCHANGE**

### **INTRODUCTION**

EDI refers to the exchange of electronic business documents i.e. purchasing orders, invoices, etc. between applications. The exchange involves no paper, no human intervention and takes place in a matter of seconds. EDI documents are formatted using published standards. EDI requires a network connection between the two companies exchanging business documents.

EDI has provided great value to trading partners especially those in certain “EDI – ENABLED” industries such as retail, automotive, and petroleum. The advent of the internet has created a common information and communications platform upon which business can be conducted. Internet provides the communications. Capabilities of EDI over a Value-Added network at a much lower price.

### **BUSINESS SYSTEMS ARE OF 3 TYPES:-**

1. NON-EDI SYSTEMS
2. PARTIALLY EDI SYSTEMS
3. FULLY INTEGRATED SYSTEMS

### **NON-EDI SYSTEMS:-**

EDI today is most widely used in large business and by smaller companies trading with larger businesses.

The entire non- EDI process requires the use of multiple clerks by both the customer and vendor to complete the transaction. The typical clerks involved in the buying cycle are Inventory control, purchasing, receiving, accounts payable, etc.. The typical clerks involved in the selling cycle are sales order processing, credit, warehouse, shipping, accounts receivable and cash receipts.

### **EXAMPLE FOR NON-EDI SYSTEMS**

SELLING	BUYING
PREPARE SALES ORDER	PURCHASE REQUISITION
SALES ORDER COPY SENT TO WAREHOUSE OR PLACED ON BACK ORDER.	SEARCH VENDOR FILES OR SELECT A VENDOR
AFTER GOODS ARE SHIPPED, INVOICE IS PREPARED.	PREPARE PURCHASE ORDER
MAIL INVOICE TO CUSTOMER	MAIL PURCHASE ORDER TO VENDOR
	RECEIVE INVOICE & VERIFY ACCURACY
	PREPARE CHECK AND MAIL CHECK.

From the above example, as many as eleven clerks are involved in the process from start to finish.

### **EDI layered architecture:**

- **Semantic (or application) layer**
- **Standards translation layer**
- **Packing (or transport) layer**
- **Physical network infrastructure layer**

<b>EDI Semantic layer</b>	Application level services	
<b>EDI standard layer</b>	<b>EDIFACT business form standards</b>	
	<b>ANSI X12 business form standards</b>	
<b>EDI Transport layer</b>	<b>Electronic mail</b>	<b>X.435,MIME</b>
	<b>Point to point</b>	<b>FTP,TELNET</b>
	<b>WWW</b>	<b>HTTP</b>
<b>Physical layer</b>	<b>Dial up lines, Internet, i -way</b>	

### **EDI semantic layer:**

- Describes the business application
- Procurement example
  - Requests for quotes
  - Price quotes
  - Purchase orders
  - Acknowledgments
  - Invoices
- Specific to company & software used

: **standard layer** Standards translation

- Specifies business form structure so that information can be exchanged
- Two competing standards
  - American National Standards Institute (ANSI)X12
  - EDIFACT developed by UN/ECE, Working Party for the Facilitation of International Trade Procedures

### **EDI transport layer**

- How the business form is sent, e.g. post, UPS, fax
- Increasingly, e-mail is the carrier
- Differentiating EDI from e-mail
  - Emphasis on automation
  - EDI has certain legal status

### **Physical network infrastructure layer**

- Dial-up lines, Internet, value-added network, etc.

## **VALUE – ADDED NETWORKS(VANS)**

The EDI features are implemented in the organization through third party network services, generally called Value-Added-Networks.(VAN).The services provided by most VANS include

1. EDI translation s/w
2. Security assurances of data
3. Reliability of services due to multiple
4. Telecommunication links
5. EDI systems development assistance
6. Employee training sessions.

## **ROLE OF VAN**

1. To execute only authorized transactions with valid trading partners.
2. To enable the VAN to distinguish authorized transactions and valid trading partners.

Companies view EDI messaging as a function to be outsourced to a specialist. VANS provide this outsourcing function and serve as a messaging station for trading partners. Messaging can be transmitted from one party's VAN to the other party's VAN. When author trading partner send a request for information to VAN .VAN transmit the data immediate back to the requesting partner without needing to contact to the vendor.

If VAN does not have the requested data, it request the vendor for the data.  
After getting the data from the vendor, it sends back to the trading partners.



## **FULLY INTEGRATED EDI SYSTEMS**

Fully integrated EDI systems encompass electronic data sharing throughout all aspects of the purchasing and payment cycles.

1. The processing of the actual payment and remittance advice is called Financial EDI.
2. Fully integrated EDI, including financial EDI, provides firms with the greatest benefits in terms of speed and accuracy.
3. Payment systems also did in electronic fund transfer.

1.Scans inventory files to determine purchase requirements	VAN (steps:3,4,5,6,7,9,10,12,13 are done through van)	6.electronically retrieves purchase order and sales order is automatically generated.
2. Scans vendor files to determine appropriate vendor.		7.Notifies ware house to pull goods
3. contact vendor systems to check inventory availability and prices.		8.records shipping date and quantities.
4. select vendor		9.sends electronic invoice to customer
5. place order(purchase order)		13.receives electronic notification of funds transferred and remittance advice.
10.receives electronic invoice		
11. verifies amount charged and goods received.		
12.Electronically transfers funds and remittance advice		

### **PRE-REQUISITES OF EDI**

Planning for EDI implementation is an important factor for success. The step required for EDI is:-

1. Identify organizational needs for EDI
2. Weigh the cost and benefits of EDI
3. Identify EDI business partners
4. Obtain top management approval
5. Form an EDI project team
6. Education & training
7. Decide on EDI standards
8. Decide on the connection options
9. Implementation planning.

### **EDI: LEGAL, SECURITY AND PRIVACY ISSUES**

In EDI, Trading is done between countries and corporations.

- In EDI, legal issues and computer security are important.
- Companies that deal with EDI should take the services of a lawyer during the design of EDI applications, so that evidentiary/admissibility safeguards are implemented.

There are 3 types of communications when considered for EDI issues:

- 1) Instantaneous: - If the parties are face to face or use an instantaneous communication medium such as telephone.
- 2) Delayed with postal service: - The mailbox rule provides that an acceptance communicated via Postal service mail is effectively communicated when dispatched or physically deposited.
- 3) Delayed with non postal service: - EX: - Couriers, telegram
  - Messaging systems combine features of delayed and instantaneous
  - Messaging delay is a function of the specific applications, message routing, networks traversed, system configuration and other technical factors.

One way of legal & security issue is Digital signatures. The technical uses of digital signatures are:-

1. Messages are time- stamped or digitally notarized to establish dates and times at which a recipient had access or even read a particular message.
2. These signatures are to replace handwritten signatures, as it is same legal status as handwritten signatures.
- 3 Digital signatures should have greater legal authority than handwritten signatures.

## **Business Models for E-commerce**

### **REVENUE MODEL**

In business, revenue typically consists of the total amount of money received by the company for goods sold or services provided during a certain time period. Therefore, revenue models are a part of the business model. Many online companies generate revenues from multiple income streams such as advertising, subscription, affiliate marketing etc. Online models not only sell goods or services but also contacts (e.g. banner) and information (e.g. user-data).

Five primary revenue models are described below-

#### **1. Advertising Revenue Model**

Typically, fees are generated from advertisers in exchange for advertisements, which is ultimately the classic principal among the revenue models besides sales. Even if representatives of major media companies complain about earning less money with online advertising than with advertising in print or TV, the figures indicate steadily rising revenues.

The advertising revenue model is based on contacts making it one of the indirect sources of revenue. The conventional version is display-marketing - for example wallpaper, super banner, rectangle, skyscraper- which is paid according to traffic (invoice per CPC/cost-per-click or CPX/cost-per-action).

Examples

Google (e.g. AdWords and AdSense)

Facebook

New York Times (Marketing)

## **2. Subscription Revenue Model**

Users are charged a periodic (daily, monthly or annual) fee to subscribe to a service. Many sites combine free content with premium membership, i.e. subscriber- or member-only content. Subscription fees do not depend on transactions. Subscribers use the content as long and often as they want

Examples

Publishers and content services, e.g. newspapers, magazines, tv channels - they provide text, audio or video content to users who subscribe for a fee to get access to the service or to download the new issue: New York Times, Spiegel Online, Zattoo, Netflix

Networks offer premium memberships to find business partners or former classmates, subscribers can use all services, i.e. they get any information about their account via short notifications or newsletter, receive and send e-mails, get job offers: Xing, LinkedIn, Stayfriends

Internet service providers offer the connectivity (e.g. via broadband) and services around (security software for download, e-mail-services): T-Online, AOL

## **3. Transaction Fee Revenue Model**

A company receives commissions based on volume for enabling or executing transactions.<sup>21</sup> The revenue is generated through transaction fees by the customer paying a fee for a transaction to the operator of a platform. The company is a market place operator providing the customer with a platform to place his transactions. During this process the customer may be presented as a buyer as well as a seller. To actively participate in this e-market, customers must register, so both parties of a transaction taking place are identified. From a business perspective, the offer is determined by others as customers offer their goods online and are acting as sellers. The amount of the transaction fee can be both – fixed and percentage calculated.

### **Examples**

- eBay
- Amazon

## **4. Sales Revenue Model**

Wholesalers and retailers of goods and services sell their products online. The main benefits for the customer are the convenience, time savings, fast information etc. The prices are often more competitive. In terms of online sales there are different models such as market places as common entry points for various products from multiple vendors.

### **Examples**

- the shops of single companies, sometimes based on web-catalogs (combines mail, online and telephone-ordering): Otto
- e-tailers operating solely over the web: Amazon



- marketplaces: [Buy.com](#), [Etsy](#)
- live shopping: [iBood](#), [guut.de](#), [woot!](#)
- shopping clubs: [brands4friends](#), [vente-privee.com](#)

## 5. Affiliate Revenue Model

The affiliate program is an online distribution solution which is based on the principle of commission. Merchants advertise and sell their products and services through links to partner-websites. It is a pay-for-performance model: Commissions are only paid for actual revenue or measurable success.<sup>8)</sup> An affiliate-link includes a code, which identifies the affiliate. That's how clicks, leads or sales are tracked. The affiliate therefore acts as the interface between merchants and customers. This model leads to a win-win situation: the merchants sell their products or services and the affiliates get their commissions. Variations include banner exchange, pay-per-click and revenue sharing programs. The affiliate model is well-suited for the web and therefore very popular.

### Examples

- [Amazon](#)
- [affilinet](#)

## E-Commerce Business models based on strategies

There are mainly 4 types of business models based on transaction party.

### Business-to-Consumer (B2C)

In a Business-to-Consumer E-commerce environment, companies sell their online goods to consumers who are the end users of their products or services. Usually, B2C E-commerce web shops have an open access for any visitor, meaning that there is no need for a person to login in order to make any product related inquiry.

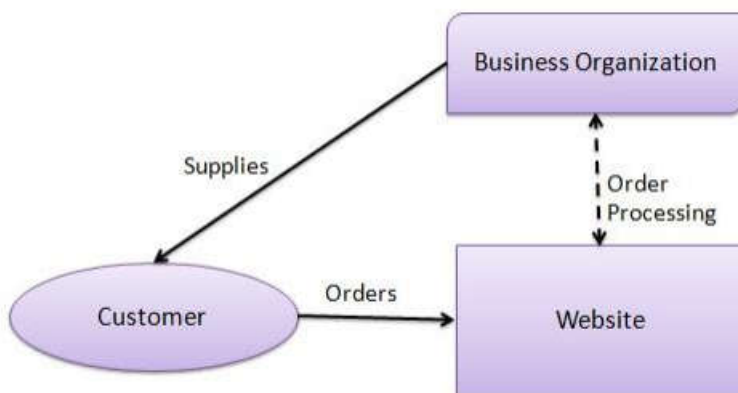

### Business-to-Business (B2B)

In a Business-to-Business E-commerce environment, companies sell their online goods to other companies without being engaged in sales to consumers. In most B2B E-commerce environments entering the web shop will require a log in. B2B web shop usually contains customer-specific pricing, customer-

specific assortments and customer-specific discounts. It includes the IOS transactions and electronic market transactions between organizations.

- IOS Transactions means Inter Organizational Information Systems refers to flow of standard transactions information between business partners, such as placing orders, building or paying.

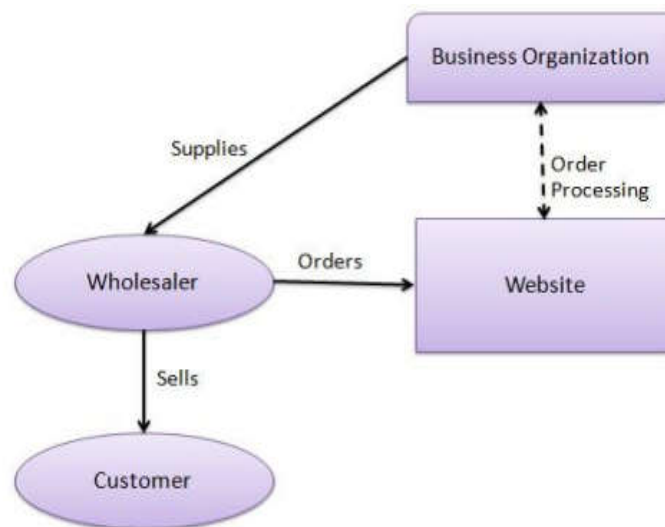

### Consumer-to-Business (C2B)

In a Consumer-to-Business E-commerce environment, consumers usually post their products or services online on which companies can post their bids. A consumer reviews the bids and selects the company that meets his price expectations.

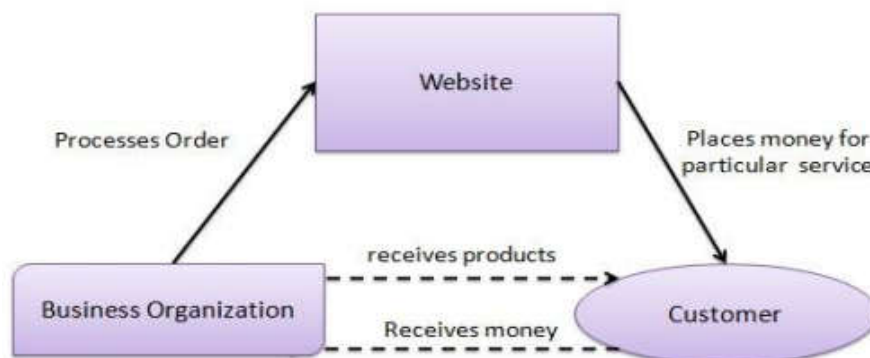

## Consumer-to-Consumer (C2C)

In a Consumer-to-Consumer E-commerce environment consumers sell their online goods to other consumers. A well-known example is eBay.

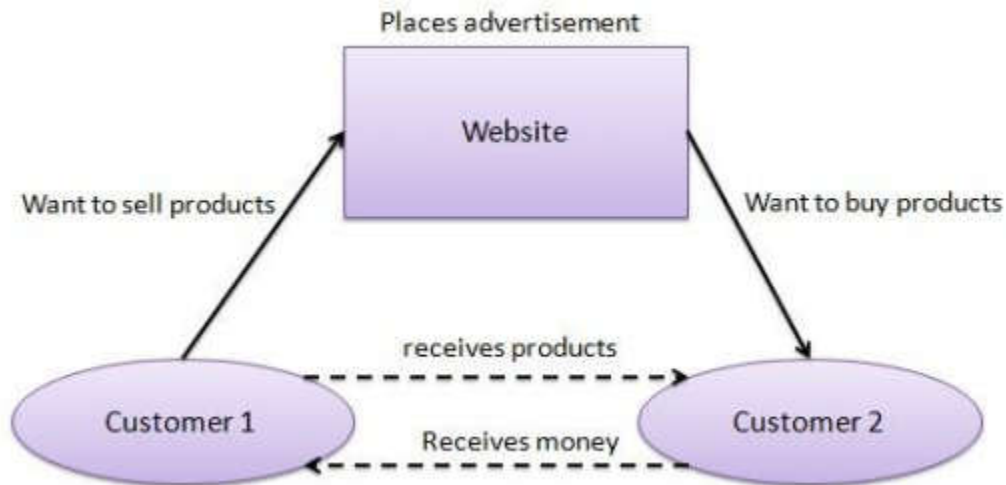

## Marketing on the web

Internet Marketing Techniques:

Internet marketing techniques are of 2 types:

1) Passive Techniques.

2) Aggressive Techniques.

1) Passive Techniques: Passive techniques are considered to be those methods that require the user to 'pull' the information from the website.

2) Aggressive Techniques: Aggressive techniques are considered to be those techniques in which the website "pushes" the information on to the customer regardless of whether the consumers is interested or not.

Some of the marketing techniques:

- Solicited, targeted e-mail.
- Interactive sites.

- Banner advertising.
- Off-line advertising.
- Unsolicited targeted e-mail.
- Spam Mail.
- E-mail, chain letters.

Solicited, Targeted E-mail:

E-mail marketing has become a popular medium because of its relatively low-cost and the ability to send HTML messages containing full color pictures of products, as well as links to order from pages. The transmit of an e-mail message to a solicited, targeted list is a method used to visitors to a website that requires acts by both the website and the visitor. This mechanism allows a business to maintain regular contract with customers and drive traffic to websites or other products.

Because the user requests the information this type of internet marketing technique is considered to be “pulled” by the consumer with the help of the website.

This Technique comes under passive Techniques.

Interactive Sites:

Some sites may exhibit initiative to attract initial and subsequent visitors to their site by providing general information in an interactive fashion.

Banner Advertising:

Online Banner advertising, off-line advertising one comes under aggressive advertising techniques. Online banner advertising a service sold. Internet marketing firms. Can be very effective. A major advantage is that the banner’s effectiveness, in terms of a visitors to site is easily monitored.

Off- Line Advertising:

The method used to promote website is off-line advertising, such as television, radio and print. These advertising mechanisms are also relatively more costly than previously mentioned methods.

Unsolicited, Targeted E-mail:

The method of on-line advertising that unsolicited, targeted email advertising to past visitor or customers. This type of advertising is aggressive in that the visitor or customer does not specifically request additional sales or promotion items. When conducted properly, these methods can be effective.

Spam mail:

Even more aggressive factices to attract customers is the sending of unsolicited e-mail advertisements to individuals or business that have never visited the site. The e-mail address may be purchased or traded with another business. The on –line equivalent of junk-mail- that is sent out repeatedly is referred to as spam mail.

Spam is referred to as “Postage due marketing “because the thousands of messages sent reside on the recipients host computers until they are deleted, and the storage of such messages cost business money.

E-mail chain letters:

Another low-cost, aggressive advertisement technique used on the internet is e-mail chair letters. E-mail chair letters typically require that a user visit site and register.

### **Marketing ( Web – Based marketing):**

The www provides an exciting and powerful new distribution channel for marketers. Web –based electronic commerce is providing marketers with an exciting new marketing channel.

Marketing is the process of planning and executing the conception, pricing, promotion, and distribution of ideas, goods and services to create exchanges that satisfy individual and organizational goals.

The www presents a new venue for marketers to use and with it comes new guidelines. Web based marketing consider two issues.

1) Determine whether web-based marketing is

(i) Evolutionary- altering an existing firm’s business model.

(ii) Revolutionary- forming a new organization to realize the opportunity of marketing on the

web.

2) Consider how the various web-based marketing techniques can supplement current marketing initiatives.

The Five “P”s Applied To Internet Marketing:

A customer oriented value chair that places the customer as the center of attention, with information follows passing from a business to its customer for all facts of its operations except for own procurement where the firm inter faces with its suppliers.

The five “P” s of marketing are:

- 1) Product
- 2) pricing
- 3) Place & Distribution
- 4) Promotion
- 5) Personalization

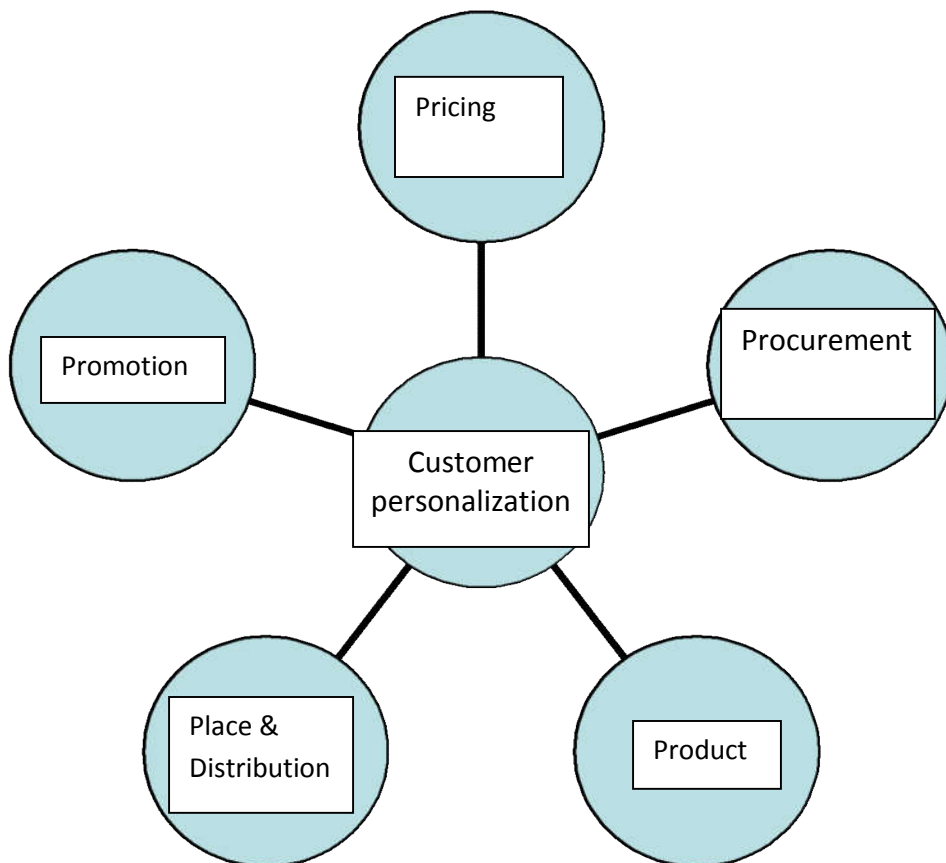

**Figure: The relationship of the five Ps and the consumer- oriented value chain**

**Product:**

Product is a good or service that a business offers to its customers without a perfect product to offer, a business cannot survive. The produce component in the marketing is related to the production section of the consumers –oriented value chain.

### **Pricing:**

The pricing of a “good” refers to the processes involved in determining the amount to charge for a specific physical good or service pricing models are typically used to determine a firm's price.

Because of the development of search engines customers are easily able to compare prices of many goods offered for sale on the internet. On-line quotation are a popular method for selling items on the internet an interesting method of pricing goods on the internet is through offers made by consumers.

### **Place (Distribution):**

Place is frequently referred to as out bound logistics or Distribution.

The Distribution task entails moving the product from the producer to the customer.

The product may travel directly from the products to the customer or it may be channeled intermediaries such as whole sales or retailers.

E-commerce involving the sale of physical goods can be very useful in exchanging information between business and delivery companies.

The physical internet itself us also a delivery channel for digital products like software data or multimedia fill.

### **Promotion:**

The sales and marketing function under the traditional marketing category called promotion.

The successful promotion of a product requires that at a minimum a positive message be received by potential customers. This message can be communicated many ways.

- 1) Paid advertising channels.
- 2) New stories and press releases.
- 3) Word of mouth.
- 4) Consumers personal experiences.
- 5) Packaging.

Another aspect of promotion is the sharing of information with customers.

### **Personalization:**

The internet is leading marketers to a fundamental paradigm shift from mass marketing to personalized marketing. Data bases and telecommunications technology make it very easy and cost – efficient to mass marketing personalized services.

Personalization on the internet refers to the ability of customers to receive personalized information

(ex: sales advertisements or coupons) or visit a website.

## **ONLINE ADVERTISING MECHANISMS**

Attracting visitors to websites is a key component to a successful web-based commerce site. The most common sources of revenue come from allowing advertisers to pay for banners on their sites is to be listed as site sponsors.

Different Techniques in online Advertising are:

- 1) Banners.
- 2) Sponsorships.
- 3) Portals.
- 4) Online Coupons.

### **Banners:**

According to internet advertising bureau (IAB), the most popular form of on-line advertising is banner advertising.

Banner advertising is used to attract visitors to a site.

Banner advertising containing text and graphic that are placed on the screens of search engines, web browser software and websites to attract the attention of www users. Banner advertising is of two types

- Click through advertisement.
- Not click- thorough advertisement.

Click through advertisement contain hypertext links to the site about which the banner is advertising.

Non Click through advertisements which does not contain hypertext links to the site.

Banner advertising is typically measured and priced according to two features.

CPM- Cost per thousand impressions.

CTR- Click through rate.

CPM- an impression refers to each time a page is viewed that is displaying the banner.

CTR- the click through rate is considered to be more important by many advertisers since it measures the no. of users "delivered" to a site.

Firms are also interested in tracking whether visitors they make a purchase from the site. So software tracking devices are available for tracking such items.



### Sponsorships:

Sponsorship is another popular on-line advertising method. Sponsorships are similar to banner in that a business gets to display a message typically just a logo, on a site a click-through may be allowed.

Sponsorships typically allow the firm's banner to stay on a site for a longer period of time or for a certain no. of days.

Sponsorships are a good mechanism for generating brand recognition's.

### Portals:

A portal is referred to a site that serves the "post of entry" on to the web. Portals are designed to give web users the information they need as they first enter the www.

Customized pages are an option, as well a customized news items and stock quotes. Portals types sell advertising space on their sites.

### Online coupons:

Online coupons are printed for use in stores or requested and sent via postal mail for use in stores when the visitor expenses the produce in which they are interested the store mails the coupons to them.

On-line coupons are also distributed from sites that specialize in distributing such coupons for businesses that subscribe to their services.

## **Electronic market places**

Electronic markets (or electronic marketplaces) are information systems (IS) which are used by multiple separate organizational entities within one or among multiple tiers in economic value chains. In analogy to the market concept which can be viewed from a macroeconomic (describing relationships among actors in an economic systems, e.g. a monopoly) as well as from a microeconomic (describing different allocation mechanisms, e.g. public auctions of telephone frequencies) perspective, electronic markets denote networked forms of business with many possible configurations:

First, the topology of electronic markets may be centralized or decentralized in nature. Centralized electronic markets are hubs which often provide services to their participants. Decentralized settings involve sequential relationships within value chains which often are found when electronic messages are exchanged directly between businesses (electronic data interchange, EDI).

Second, the services provided by electronic markets may serve infrastructural or allocation purposes. Among the infrastructure services are routing, messaging, identification and partner directories whereas allocation services enable pricing process which in turn may be static or dynamic in nature. Typical implementations are catalogs, exchanges and auctions.

Third, the relationships of actors involved in electronic markets may be stable or atomistic in nature. The former usually refers to classical supply chains where business collaborate during a longer period of time. In the latter case, the transaction partners are only stable for a single transaction. This is usually to be found in auction and other exchange settings.

This leads to two definitions: In a narrow sense Electronic Markets are mainly conceived as allocation platforms with dynamic price discovery mechanisms involving atomistic relationships. Popular examples originate from the financial and energy industries. In a broader sense, price discovery is not critical for electronic markets. This covers all forms of electronic collaboration between organizations and consumer as well as vice versa.

### **Electronic Auctions**

The electronic auction (e-Auction) is an e-business between auctioneers and bidders, which takes place on an electronic marketplace. It is an electronic commerce which occurs business to business (B2B), business to consumer (B2C), or consumer-to-consumer (C2C).

The auctioneer offers his goods, commodities or services on an auction side on the internet. Interested parties can submit their bid for the product to be auctioned in certain specified periods. The auction is transparent, all interested parties are allowed to participate the auction in a timely manner.<sup>1</sup>

The two major types of the electronic auction are:

1. **forward auction** in which several buyers bid for one seller's goods
2. **reverse auction** in which several sellers bid for one buyer's order.

Advantages of online auction-

- **No physical location**

The products for auction do not need any physical location in case of online auction. The inventory can be managed online and upon sale the product can be shipped physically. This makes it flexible to hold an auction online site.

- **Convenience**

The bidder can participate in auction from anywhere at anytime through online auction. There is no limitation regarding the time, place, or person to conduct online auction. Bidders can participate in auction from home or office using the computer terminal.

- **Rich information**

The related information about each auction product is neatly presented on the website. Bidders can peruse all the documents related to the products before participating in the auction. There is no confusion to get information at fingertips.

- **Time& money saving**

Online auction saves time and money. There is no dedicated time required to travel and reach an auction place. Just logging into the site makes it possible for the user to participate in auction which also saves money spent for reaching the auction spot.

Disadvantages of online auction-

- **Prolonged time**

In normal auction the time for auction is fixed which will not be changed. But in the case of online auction, the timer is reset with 20 or 30 seconds when a bidder places a bid which makes the auction time to be prolonged causing time delay in closing the auction.

**Anonymous bidder**

The online auction does not take place face to face which creates anonymous bidders. The auctioneers cannot have a hold on who is participating in the bidding. This can lead to anonymity in identifying the bidders.

- **Product genuineness**

One can view only the product photo on the auction website. One cannot inspect the product about its condition and usability physically which may lead to lack of product genuineness. Some of the online auction does not support refund

- **Fake sites**

The auction website may be sometimes fraudulent which sells fake products which will never be delivered. The product description and actual product may differ. Sometimes the product delivered may not be the product that was placed for auction leading to chaos.

## **M-Commerce**

M-Commerce or mobile commerce is process of buying and selling products and services through wireless handheld devices such as cell phones or PDAs. Though M-commerce is a new term, it has become an instant hit and is also being called as the next generation e-commerce. M-commerce lets users carry out financial transaction using mobile phones and does not always require internet. It has made the process of buying and selling products even easier due to a technology known as WAP (Wireless Application Protocol), which allows users to connect to the internet without dealing with the hassle of wires and electricity.

It also allows businesses to reach consumers even faster compared to e-commerce, as a person may not always have a computer with them, while a person will always have their cell phones on them. Promotional text messages are an example of mobile commerce. Another popular example is downloading movie tickets and airline tickets on the phone. With the constant upgrade in cellular technology, more and more possibilities are available to the consumers. Mobile applications, online banking, online shopping via phone, are also different forms of m-commerce.

Compared to M-commerce, E-commerce is more limited as it requires the use of a computer and internet connection, while mobiles work on satellites. Video conferencing is now available on mobile phones with 3G and 4G networks, without the hassle of internet. M-commerce however is costly compared to E-commerce.

## **Virtual community**

A virtual community is a social network of individuals who interact through specific social media, potentially crossing geographical and political boundaries in order to pursue mutual interests or goals. Some of the most pervasive virtual communities are online communities operating under social networking services.

Virtual communities all encourage interaction, sometimes focusing around a particular interest or just to communicate. Some virtual communities do both. Community members are allowed to interact over a shared passion through various means: message boards, chat rooms, social networking sites, or virtual worlds

- Purpose of virtual communities:

Virtual communities are used for a variety of social and professional groups; interaction between community members varies from personal to purely formal. For example, an email distribution list operates on an informational level.

- Internet-based virtual communities-

The explosive diffusion of the Internet since the mid-1990s fostered the proliferation of virtual communities in the form of social networking services and online communities. Virtual communities

may synthesize Web 2.0 technologies with the community, and therefore have been described as Community 2.0, although strong community bonds have been forged online since the early 1970s on timeshare systems like PLATO and later on Usenet. Online communities depend upon social interaction and exchange between users online. This interaction emphasizes the reciprocity element of the unwritten social contract between community members.

- Impacts of virtual communities

-On health

Concerns with a virtual community's tendency to promote less socializing include: verbal aggression and inhibitions, promotion of suicide and issues with privacy. However, studies regarding the health effects of these communities did not show any negative effects. There was a high drop-out rate of participants in the study. The health-related effects are not clear because of the lack of thoroughness and the variation in studies done on the subject.

-On civic participation

New forms of civic engagement and citizenship have emerged from the rise of social networking sites. Networking sites acts as a medium for expression and discourse about issues in specific user communities. Online content sharing sites have made it easy for youth to not only express themselves and their ideas through digital media, but also connect with large networked communities. Within these spaces, young people are pushing the boundaries of traditional forms of engagement such as voting and joining political organizations and creating their own ways to discuss, connect, and act in their communities.

Civic engagement through online volunteering has shown to have positive effects on personal satisfaction and development. Some 84 per cent of online volunteers found that their online volunteering experience had contributed to their personal development and learning.

- Types of virtual communities-

### 1. Internet message boards:

An online message board is a forum where people can discuss thoughts or ideas on various topics. Online message centers allow users to choose which thread, or board of discussion, users would like to read or contribute to. A user will start a discussion by making a post on a thread. Other users who choose to respond can follow the discussion by adding their own post to that thread. Message boards are not conversation based because user responses do not have to take place right away. Whenever the user revisits the message board, he/she can make a response. Unlike a conversation, message boards do not have an instantaneous response and require that users actively go to the site to check for responses. Anyone can register to

participate in an online message board. A message board is unique because people can choose to participate and be a part of the virtual community, even if they choose not to contribute their thoughts and ideas. Registered users can simply view the various threads or contribute if they choose to. Message boards can also accommodate an almost infinite number of users, while the number of users who can be accommodated by a single chat room is limited at least in practice.

## 2. Online chat rooms:

Shortly after the rise of interest in message boards and forums, people started to want a way of communicating with their "communities" in real time. The downside to message boards was that people would have to wait until another user replied to their posting, which, with people all around the world in different time frames, could take a while. The development of online chat rooms allowed people to talk to whoever was online at the same time they were. This way, messages were sent and online users could immediately respond back. The original development by CompuServe CB hosted forty channels in which users could talk to one another in real time. The idea of forty different channels led to the idea of chat rooms that were specific to different topics. Users could choose to join an already existent chat room they found interesting, or start a new "room" if they found nothing to their liking. Real time chatting was also brought into virtual games, where people could play against one another and also talk to one another through text. Now, chat rooms can be found on all sorts of topics, so that people can talk with others who share similar interests. Chat rooms are now provided by Internet Relay Chat (IRC) and other individual websites such as Yahoo, MSN, and AOL.

## 3. Virtual worlds:

Virtual worlds are the most interactive of all virtual community forms. In this type of virtual community, people are connected by living as an avatar in a computer-based world. Users create their own avatar character (from choosing the avatar's outfits to designing the avatar's house) and control their character's life and interactions with other characters in the 3-D virtual world. It is similar to a computer game, however there is no objective for the players. A virtual world simply gives users the opportunity to build and operate a fantasy life in the virtual realm. Characters within the world can talk to one another and have almost the same interactions people would have in reality. For example, characters can socialize with one another and hold intimate relationships online.

This type of virtual community allows for people to not only hold conversations with others in real time, but also to engage and interact with others. The avatars that users create are like humans. Users can choose to make avatars like themselves, or take on an entirely different

personality than them. When characters interact with other characters, they can get to know one another not only through text based talking, but also by virtual experience (such as having avatars go on a date in the virtual world). A chat room form of a virtual community may give real time conversations, but people can only talk to one another. In a virtual world, characters can do activities together, just like friends could do in reality. Communities in virtual worlds are most similar to real life communities because the characters are physically in the same place, even if the users who are operating the characters are not. It is close to reality, except that the characters are digital. Second Life is one of the most popular virtual worlds on the Internet. Whyville offers a good alternative for younger audiences where safety and privacy are a concern. In Whyville you use the simulation aspect of the virtual world to experiment and learn about various phenomena.

#### 4. Social network services:

Social networking services are the most prominent type of virtual community. They are either a website or software platform that focuses on creating and maintaining relationships. Facebook, Twitter, and MySpace are all virtual communities. With these sites, one often creates a profile or account, and adds friends or follow friends. This allows people to connect and look for support using the social networking service as a gathering place. These websites often allow for people to keep up to date with their friends and acquaintances' activities without making much of an effort. On Facebook, for example, one can upload photos and videos, chat, make friends, reconnect with old ones, and join groups or causes. All of these functions encourage people to form a community, large or small, on the Internet.